

[www.altech.it](http://www.altech.it)

by **AL  
TECH**  
Advanced Labelling Technologies



**AL**  
**line**

**Sistema di etichettatura lineare**

Linear labelling systems

*Système d'étiquetage linéaire*

 **presa**  
ALONG YOUR LINES

## ALline C



La configurazione ALline C è adatta all'applicazione di etichette avvolgenti su prodotti cilindrici, tipicamente prodotti alimentari in vasetti o bottiglie di vetro o metallo; o prodotti chimici, cosmetici e farmaceutici in flaconi di plastica, vetro o metallo. Il suo basamento compatto può accogliere una testata etichettatrice laterale della serie ALstep o ALritma. Per la movimentazione del prodotto può accogliere vari tipi di convogliatori, sia a scaglie che a tappeto, in varie dimensioni. Per il distanziamento è disponibile una vasta gamma di dispositivi differenti, da scegliere in funzione dei prodotti e delle prestazioni. Per provvedere all'avvolgimento dell'etichetta sono previsti diversi dispositivi, adatti sia all'etichettatura avvolgente senza fase, sia all'etichettatura in fase. Può essere dotato di tutti gli opzionali comuni alla serie ALline, nonché di tutti i sistemi di controllo per la verifica dell'etichettatura.



ALline C is configured to apply wrap-around labels to cylindrical products, usually glass or metal jars and bottles containing foodstuff, as well as chemical, cosmetic and pharmaceutical products in plastic, glass or metal vials. Its compact base can be equipped with a side labelling head of the ALstep or ALritma series. With regard to products handling, ALline C can be fitted with several kinds of slats and belt conveyors, featuring different sizes. It also comes with a wide range of products spacers, to be chosen according to products and performances. An array of devices are

available for wrap-around labelling, all of which are suitable for both wrap-around labelling and in-phase labelling. It can be equipped with the complete range of options of the ALline series, as well as with all labelling checking devices.



La configuration de la version ALline C permet la dépose en banderoulage sur des produits cylindriques, généralement des produits alimentaires contenus dans des pots ou des bouteilles en verre ou métal, ainsi que des produits chimiques, cosmétiques et pharmaceutiques conditionnés dans des flacons en plastique, verre ou métal. Sa base compacte peut être dotée d'une tête d'étiquetage de la série ALstep ou ALritma. Pour la manutention du produit, ALline C peut être équipée de plusieurs types de transporteurs, tant à écailles qu'à tapis, de différentes dimensions. Des nombreux dispositifs d'espacement, à sélectionner en fonction des produits et des performances, sont également disponibles. La dépose en banderoulage peut être effectuée à l'aide de différents dispositifs permettant tant l'étiquetage en banderoulage sans phase, que l'étiquetage en phase. Cette version peut être également dotée de tous les dispositifs optionnels de la série ALline, ainsi que de tous les systèmes de contrôle d'étiquetage.



- Distanziatore a coclea MD14
- Timing screw MD14
- Espaceur à vis sans fin MD14



- Distanziatore a rullino MD12
- Infeed gapping wheel MD12
- Espaceur a rouleau MD12



- Rotolatore MR12
- Wrap-around unit MR12
- Banderoleur MR12



- Unità per etichettatura in fase MR16
- In-phase labeling unit MR16
- Dispositif pour étiquetage in phase MR16



## ALline E



La configurazione ALline E è stata studiata per l'applicazione di due etichette fronte/retro su prodotti ellittici o rettangolari, tipicamente prodotti alimentari, cosmetici, farmaceutici, chimici in contenitori di plastica, di vetro o di metallo. Il suo basamento può accogliere due testate laterali contrapposte della serie ALritma. Per la movimentazione e il distanziamento dei prodotti sono disponibili le unità già previste per l'ALline C, mentre per l'allineamento e la stabilizzazione esistono vari dispositivi dedicati. ALline E è dotato di serie di un sofisticato sistema che provvede alla perfetta sincronizzazione di tutti gli elementi della macchina, consentendo di regolare la velocità con un unico potenziometro, e di mantenere una buona etichettatura anche durante le fasi di avviamento o arresto. Per l'ALline E il ponte superiore è presente anche in assenza di cabina, e provvede ad irrigidire lo stabilizzatore superiore, conferendo notevole solidità all'insieme. ALline E, può essere dotato di alcuni dei sistemi di rotolamento previsti per ALline C, in modo da ottenere la possibilità di etichettare anche prodotti cilindrici.



ALline E has been configured to apply two front/back labels to elliptical or rectangular products, generally food, cosmetic, pharmaceutical and chemical products in plastic, glass or metal bottles and jars. Its basement can be fitted with two opposing side ALritma heads. ALline E can be equipped with the handling and spacing devices used on ALline C, whilst specific orienting

and stabilizing units are also available. As a standard feature, ALline E includes a state-of-the-art system which synchronises all its elements; not only does it make it possible to adjust the machine speed by means of a single potentiometer, but it also guarantees good quality labelling even during starting or stopping. In the ALline E the upper trestle is present even with absent cabinet, thus hardening the top stabilising belt for increased rigidity of the whole system.

ALline can be equipped with some of the wrap-around units available for ALline C, thus allowing the labelling of cylindrical products.



La configuration de la version ALline E a été étudiée pour la pose de deux étiquettes recto/verso sur des produits elliptiques ou rectangulaires, normalement des produits alimentaires, cosmétiques, pharmaceutiques et chimiques contenus dans des bouteilles ou des pots en plastique, verre ou métal. Sa base peut être dotée de deux têtes d'étiquetage latérales opposées de la série ALritma. ALline E peut être dotée de tous les dispositifs de manutention et d'espacement prévus pour ALline C, tandis que des dispositifs spécifiques sont disponibles pour l'orientation et la stabilisation des produits. La configuration standard comprend également un système particulièrement avancé synchronisant tous les composants de la machine: ce dispositif permet de régler la vitesse à l'aide d'un seul potentiomètre et assure un bon étiquetage même durant le démarrage et l'arrêt. Le pont supérieur est présent même si la cabine est absente, ce qui rend le tapis plus rigide et, par conséquent, augmente la solidité de l'ensemble. Cette version peut être munie des dispositifs banderouleurs d'ALline C pour la pose d'étiquettes même sur des produits cylindriques.



- Allineatore a cinghia ME11
- Side-belt aligner ME11
- Orientation à courroie ME11



- Orientatore a catenelle ME12
- Chains orienting unit ME12
- Orientation par chaînes ME12



- Stabilizzatore superiore MC15
- Top stabilizer MC15
- Contre-tapis supérieur MC15



- Rulli adattatori AS01
- Adapting rollers AS01.
- Rouleaux adaptateurs AS01



## ALline special



ALline può anche assumere configurazioni particolari, in base a specifiche esigenze di etichettatura. Per l'etichettatura multipla in varie posizioni del prodotto, oppure per l'applicazione ad angolo di etichette anti-riavvolgimento, è stata prevista la possibilità di integrare dei dispositivi modulari, particolarmente affidabili e collaudati. Per l'applicazione di etichette su prodotti cilindrici instabili, è possibile adottare uno speciale convogliatore a rulli orizzontali con moto continuo o alternato.

Ove invece fosse richiesta una velocità o un'autonomia particolarmente elevata, è prevista la possibilità di dotare il sistema di portabobina maggiorati e motorizzati, oppure per cadenze fino a 500 pz/min le configurazioni NON-STOP, con attivazione automatica delle testate, consentono un agevole cambio bobina senza alcuna necessità di fermare la macchina e senza scarti per mancata etichettatura.



ALline can also be specifically configured to meet special requirements. Multiple labelling in several positions, or the corner application of tamper-proof seals is possible thanks to the integration of extremely reliable and tested modular systems. The labelling of unstable cylindrical products can be performed by means of a special continuous or alternate-motion horizontal rollers conveyor. Whenever high speed or range is needed, bigger, powered unwind units can be mounted; for speeds up to 500

p/min, the NON-STOP configurations, with automatic head activation, allow an easy roll change without having to stop the machine and with no reject for non performed labelling.



ALline peut également prendre des configurations particulières pour satisfaire à des exigences d'étiquetage spécifiques. L'étiquetage multiple dans plusieurs positions, tout comme la pose à angle de cachetages anti-riavvolgimento, est possible grâce à l'intégration de dispositifs modulaires extrêmement fiables et rodés. La pose d'étiquettes sur les produits cylindriques instables peut être effectuée à l'aide d'un transporteur spécial avec rouleaux horizontaux à mouvement continu ou alterné. Au cas où une cadence ou une autonomie très élevée s'avérerait nécessaire, il est possible de doter le système de porte-bobines plus grands et motorisés; pour les cadences jusqu'à 500 p/min., les configurations NON-STOP, caractérisées par l'activation automatique des têtes, permettent de changer la bobine en toute simplicité, sans arrêter la machine et sans déchets à cause d'étiquetage non accompli.



Adattatore per sigilli AS06  
 Tamper évident adapter AS06  
 Adaptateur pour pliage scelles AS06



Pistone per piega etichetta AS08  
 Label bending piston AS08  
 Adaptateur pour pliage étiquette AS08



Rotolatore ad aspirazione MR13  
 Vacuum wrap-around unit MR13  
 Banderoleur à aspiration MR13

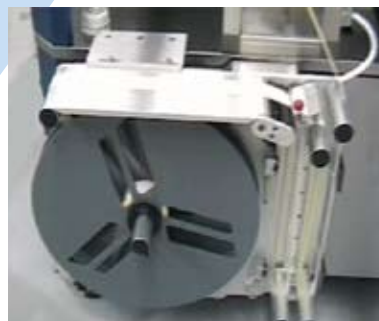

Presvolgitoro motorizzato PR06  
 Powered unwind unit PR06  
 Porte-bobine motorisé PR06





Gli impianti della serie ALline sono dei sistemi di etichettatura lineari completamente automatici. Possono essere configurati per l'etichettatura di prodotti cilindrici, di prodotti ellittici o rettangolari, oppure per la soluzione di esigenze specifiche come l'applicazione di sigilli antiviolazione, l'etichettatura di prodotti instabili o dalla forma particolare.

Quello che accomuna tutte le versioni che compongono la gamma ALline sono i criteri di progettazione d'avanguardia che, nel rispetto della normativa CE, rendono ogni macchina idonea anche a situazioni gravose, garantiscono precisione di etichettatura anche a velocità elevate, e riservano un'attenzione particolare all'operatore, che troverà le operazioni di avviamento e cambio formato sempre semplici ed intuitive.

Più in dettaglio ALline è basato sulla filosofia del "tutto all'interno", cosicché tutti gli elementi rimangono "compresi" nella struttura/cabina, protetti dallo sporco e da urti accidentali. La struttura in carpenteria blu cobalto (o acciaio Inox) è estremamente robusta e, grazie al suo design accattivante, qualifica l'intera linea di confezionamento. Il quadro comandi è in posizione elevata, protetto dai liquidi di lavaggio, o da perdite dei prodotti. Nelle configurazioni standard la cabina antinfortunistica opzionale, si integra perfettamente nella struttura di base e provvede anche alla chiusura del soffitto. Le portine hanno un'apertura a pantografo particolarmente ergonomica e poco ingombrante. Il passaggio cavi è completamente interno alla struttura per una maggior pulizia, protezione degli stessi, nonché per un più pulito impatto estetico. Il cambio formato è assistito da microprocessore. Le regolazioni meccaniche sono ridotte al minimo, e sono state studiate perché ogni elemento abbia un'affidabile ripetibilità di posizionamento e un serraggio stabile durante il funzionamento.



The ALline labelling systems are automatically-operated in-line systems which can be configured for the labelling of cylindrical, elliptical or rectangular products; moreover, they can suit specific requirements, such as the application of tamper-proof seals or labelling of singularly shaped products. All ALline systems have equally been designed according to cutting edge designing criteria which, in strict

compliance with CE regulations, make every machine suitable for even the harshest of conditions, guarantee great labelling accuracy even at high production speeds and feature a high degree of operator-friendliness, as the start and change-over operations are particularly simple and intuitive.

In more detail, ALline is based on the "built-in" philosophy, which means that all components are "included" in the structure/cabinet, well protected against dirt and accidental bumps. The cobalt blue (or stainless steel) structure is extremely sturdy and, thanks to its eye-catching design, it qualifies the whole packaging line. The control panel is located in an upper position, well protected against washing liquids or product loss. In standard configurations, the optional safety cabinet perfectly fits into the basic structure, thus sealing the ceiling; its pantograph style doors are extremely ergonomic and considerably reduce the footprint.

The completely internal cable path guarantees simpler cleaning, improved protection as well as a cleaner design. The microprocessor-controlled format change-over is coupled with minimum mechanical adjustments, which have been engineered so that every component can be repeatedly positioned in a simple and reliable manner and firmly secured during its operations.





Les installations d'étiquetage de la série ALline sont des systèmes linéaires complètement automatiques, qui peuvent être configurées pour la dépose sur des produits cylindriques, elliptiques ou irréguliers, ainsi que pour répondre à des exigences spécifiques, telles que l'application de cachetages anti-violation et la pose d'étiquettes sur des produits instables ou de forme particulière.



Toutes les versions de la série ALline sont axées sur des critères de conception d'avant-garde strictement conformes aux normes CE, peuvent être utilisées même dans des conditions ardues, garantissent une bonne précision de positionnement même à haute cadence et s'avèrent tout particulièrement pratiques à régler par l'opérateur, grâce aux opérations de démarrage et de change de format simples et intuitives.

Plus en détail, ALline repose sur la philosophie "tout à l'intérieur", ce qui signifie que tous ses composants sont "inclus" dans la structure/cabine, bien protégés de la saleté et d'éventuels chocs accidentels. La structure bleu



 Protezioni per cavi elettrici  
 Protections for cables  
 Protections des câbles électriques



 Colonna di supporto  
FDO5-FR11-FC10  
 Supporting bracket  
FDO5-FR11-FC10  
 Colonnes de soutien  
FDO5-FR11-FC10

cobalt (ou en acier inoxydable) est extrêmement solide et pour son dessin captivant qualifie l'ensemble de la ligne de confectionnement. Le tableau de contrôle est positionné en haut, à l'abri des liquides de lavage ou des pertes de produits. Dans les configurations standards, la cabine de sécurité optionnelle s'intègre parfaitement dans la structure de base et couvre le plafond; l'ouverture à pantographe de ses portes s'avère très ergonomique et réduit l'encombrement. Les câbles se trouvent entièrement à l'intérieur de la structure, ce qui garantit une meilleure propreté et protection, ainsi qu'un impact esthétique plus propre. Le change de format par microprocesseur s'accompagne de réglages mécaniques particulièrement simples, qui ont été étudiés afin que chaque composant soit continuellement positionné de façon simple et fiable et ait un serrage stable durant le fonctionnement de la machine.



Grazie alla loro modularità tutti gli impianti ALline possono essere arricchiti con dispositivi opzionali che ne accrescono autonomia e prestazioni, tra cui: sistemi di inclinazione micrometrica delle testate e contagiri sui volantini, marcatori per lotti o scadenze, piatti rotanti di alimentazione ed accumulo, controlli del flusso dei prodotti (accumulo/carico minimo), controlli di avvenuta etichettatura con espulsione automatica.





Thanks to their high modularity, all ALline systems can be equipped with an array of devices, thus enhancing their range and performance. Such devices include the following: micrometric adjustment for head inclination and revolution counters for adjustment handles, coders for batches or sell-by dates, rotary infeed and outfeed tables, checking device for product flow (minimum infeed/outfeed), checking devices for performed labelling, with automatic ejection.



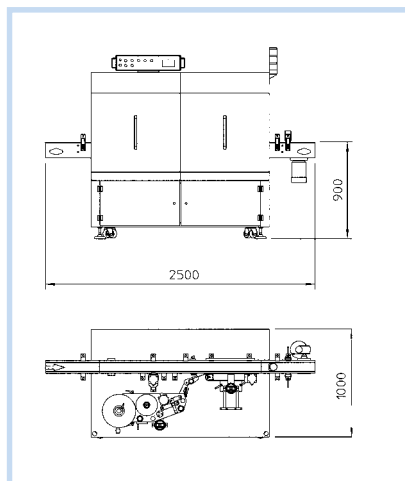
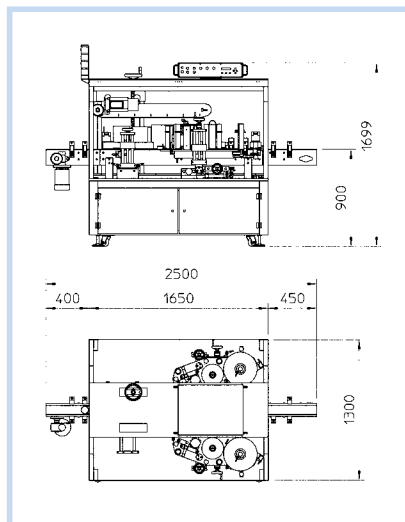

Grâce à leur modularité, tous les systèmes ALline peuvent être munis de dispositifs qui en augmentent l'autonomie et les prestations, tous comme les suivants: réglage micrométrique d'inclinaison des têtes et poignées de réglage avec compte-tours, marqueurs pour lots et dates limites de consommation, tables tournantes d'alimentation et accumulation, contrôle du flux des produits (accumulation/chargement minimum), contrôle d'étiquetage accompli avec expulsion automatique.



 Marcatore a caldo SC15  
 Hot-foil printing unit SC15  
 Marqueur à chaud SC15



 Tavola rotante di accumulo MT19  
 Out feed rotary table MT19  
 Table tournante d'accumulation MT19

#### CARATTERISTICHE TECNICHE

- Tensione d'alimentazione: 400 V 50 Hz trifase
- Potenza assorbita: 1 Kw
- Prestazioni: fino a 500 pz/min.



#### TECHNICAL SPECIFICATION

- Power Supply: 400 V 50 Hz three-phase
- Power Consumption: 1 Kw
- Performances: up to 500 pcs/min. adjustable

#### CARACTÉRISTIQUES TECHNIQUES

- Tension d'alimentation: 400 V 50 Hz three-phase
- Puissance absorbée: 1 Kw
- Cadence: jusqu'à 500 pièces/min.



 Controllo avvenuta etichettatura CS03-CS04-CS05  
 Label presence control CS03-CS04-CS05  
 Contrôle étiquetage arrivé CS03-CS04-CS05



For more info, please contact:  
**Presa NV**, Brusselsesteenweg 558,  
 3090 Overijse, Belgium  
 Phone: +32 2 657 02 22  
 E-mail: [marketing@presa.com](mailto:marketing@presa.com)  
 Web: [www.presa.com](http://www.presa.com)

